

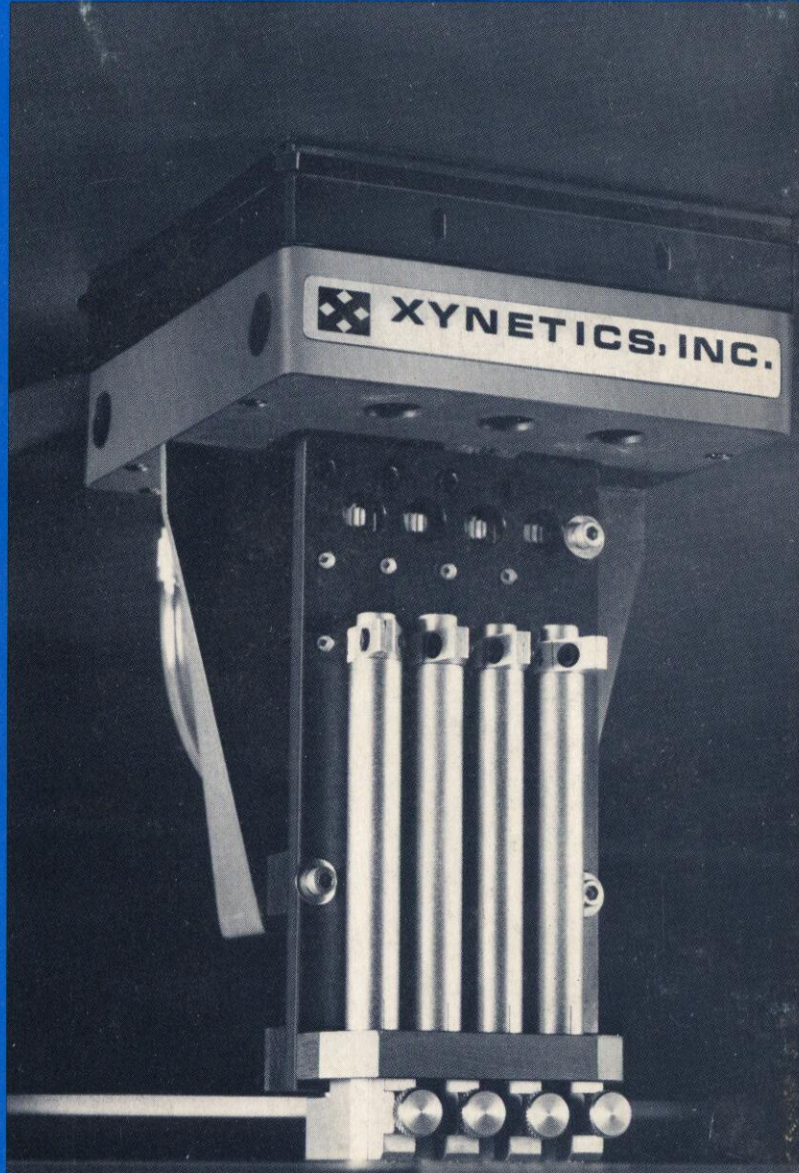

XYNETICS GRAPHICS PLOTTING SYSTEMS

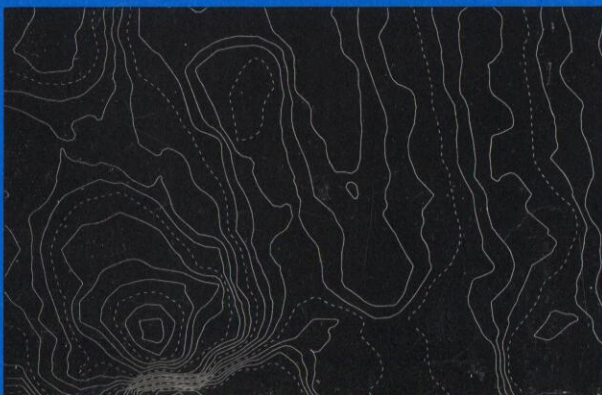
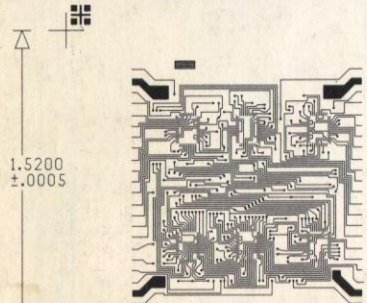
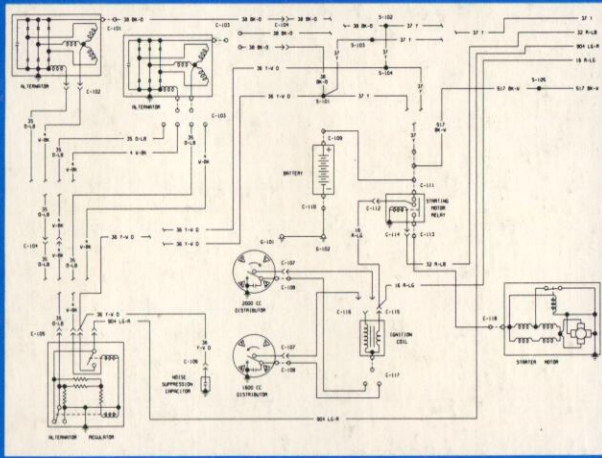
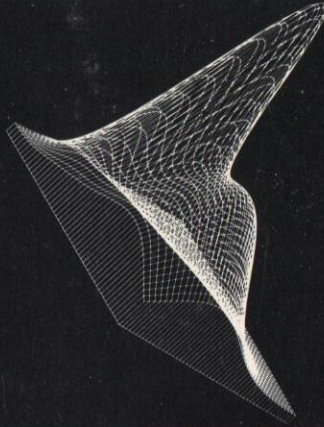
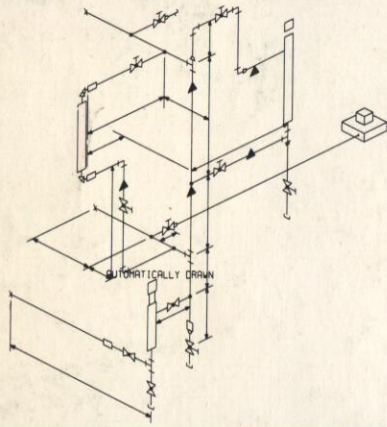

SERIES 1000 HIGH PERFORMANCE DRAFTING SYSTEM

Xynetics Drafting Systems provide a unique capability for any organization requiring precise, high-speed plotting of such graphics as logic diagrams, contour maps, schematic drawings, highway plans or three-dimensional perspectives. Productive Xynetics installations are at work today in locations ranging from engineering firms to government agencies to electronics companies. The same demonstratable efficiency and capacity of Xynetics Drafting Systems can be easily tailored to match your specific requirements.

FEATURES THAT MEAN EFFICIENCY FOR YOU

Throughput Xynetics delivers the performance that today's productivity needs. Designed to provide on-line or off-line high speed plotting, the Xynetics series 1000 will produce graphic output at the rate of up to 40 inches per second (ball point), and up to 25 inches per second (wet ink).

This capability matches or exceeds today's host computers plot formatting, and provides the dynamic turn-around so much needed in today's production environment.

High Quality Precision Manufactured accuracy eliminates calibration and maintains a fine .001 in. (.025mm) resolution. Accuracy and repeatability of $\pm .005$ in. (.127mm) and $\pm .001$ in. (.025mm), respectively, over the total drawing area, assures superior graphic output consistency.

Reliability Xynetics' patented linear reluctance motor drive eliminates the awkward system of gears, wire cable and lead screws still used in other systems. The Xynetics plotting head rides on a frictionless air-cushion making "wear-out" a thing of the past.

This state-of-art technology assures the Xynetics user of minimum down time and delivers a system that still operates at its' best years from now . . . even on multi-shift operation!

Three Table Sizes Satisfying the broadest range of drawing sizes, Xynetics offers effective plotting areas of 33" x 44" (84cm x 112cm), 43" x 56" (109cm x 142cm) and 58" x 87" (147cm x 222cm) for models 1050, 1100 and 1200 respectively.

Each table permits standing or seated operator convenience, with all controls located at the left corner of the table. The plotting surface has a vacuum hold-down system capable of handling all commonly used graphic arts materials. The plotting area is illuminated by fluorescent lamps for easy visibility of plot progress. The addition of a C62 Controller and a WA40 4-pen in-line marker system makes a complete system for general plotting applications.

Multi-application Software Software available from Xynetics includes a basic standard Fortran Level package consisting of a versatile arrangement of call routines. This powerful system coupled with other available Xynetics application programs gives the Xynetics customer operational start-up ease and follow-on growth capability.

Experience With the installation of hundreds of plotter systems, worldwide, Xynetics has gained the experience necessary to maintain a deserved high customer-satisfaction level.

A worldwide network of field maintenance and systems support personnel is available to match the requirements of the graphics plotting marketplace, now and into the future.

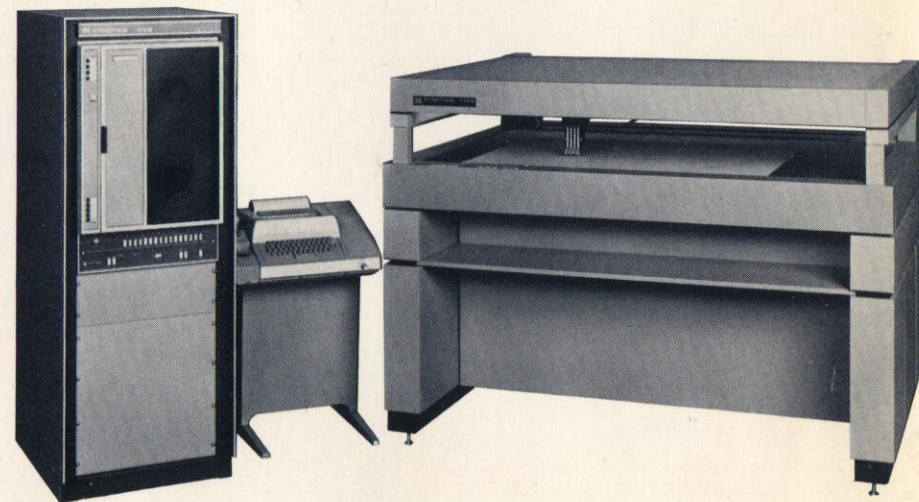

Model C 62 Controller

Model 1100 Drafting Table

SERIES 1000 ACCESSORIES

CONTROLLERS FOR OFF-LINE AND ON-LINE USE

C62 Off-Line Controller This controller operates in a continuous "look-ahead" mode making it possible for the positioner to plot one line after another without returning to zero velocity. This feature of the C62 allows any series 1000 table to plot all geometry graphics with maximum throughput.

The C62 consists of a 16 bit word stored program controller, with memory, Magnetic Tape Drive (7 track-tridensity, 9 track 800pi, or 9 track 1600 multi-format), slope generator, interface electronics and stand-alone teletypewriter. The C62 accepts any Xynetics formatted plot tape from a variety of host computer systems.

C64 On-Line Controller This controller, which also operates in "look-ahead" mode, consists of a 16 bit stored program controller, with memory, slope generator, interface electronics and interconnecting cables. The C64 can be connected to all mini-computer based systems through either a 16 bit parallel TTL or standard RS-232 interface. Transmission of data is on a demand basis with no real time constraints on the host CPU.

SOFTWARE FOR ADDED CAPABILITY

Host Package Formatting software is available for all large mainframe systems as well as most mini-computer systems. This package provides plot tapes for off-line (C62) operation or formatting necessary to drive the Xynetics plotter in an on-line (C64) configuration.

Functional Package This package provides an extensive set of sub-routines specially geared to drafting, business or scientific applications. Together with the basic system, the functions available here will allow the user to streamline and tailor the Xynetics system to precisely meet his operational and production needs.

Contouring Package Written in Fortran language, this optional software is a generalized surface approximation, contouring and plotting system. Processed as part of a "host" CPU's main program, the user has the tools necessary to generate a wide variety of contour maps. It is equally functional for use in geophysics, meteorology and magnetic field surface area applications.

Graphic Display System Xynetics' enhanced version of the standard system provides "quick-look" graphics display capability prior to hard copy plot.

Windowing Package This program provides the capability of plotting a rectangular area or "window" from a data set which might normally lie off the plotting surface. The user controls the placement and size of the window through various commands. Xynetics' graphic display system comes supplied with this program.

Flowgram This program enables the user to easily generate and plot flow charts from entered Fortran programs.

Emulator Systems A variety of emulators are available that use, as input, plot tapes generated for other systems and re-formats to Xynetics plot code. These programs allow a user to move to the advantages of Xynetics.

TABLE ATTACHMENTS FOR INCREASED ADAPTABILITY

WA40 — In-Line Marking System This system is a precision holder-actuator unit which accepts from one to four different work attachments. These include wet ink and ball point pens, scribe tips and strippable film cutters. The WA40 is required on all 1000 series drafting systems and provides precision alignment and quick-change features for the various work attachments.

WA41 Scribe Kit Four scribe adapter assemblies with tip diameters of .003", .004", .005" and .007" are supplied. The scribes, intended for use on scribe coat material, are downward force adjustable as mounted on the WA40 Marking System.

WA47 Film Cutter Kit The kit provides four cutting tools positioned on the WA40 to cut 0° to 360° in 45° increments.

TA70 Paper Advance System An automatic, pushbutton or manual paper advance capability is available.

TA60 Axis Position Display This option, mounted on the table, displays the absolute X-Y position of the plot head through the use of LED lights.

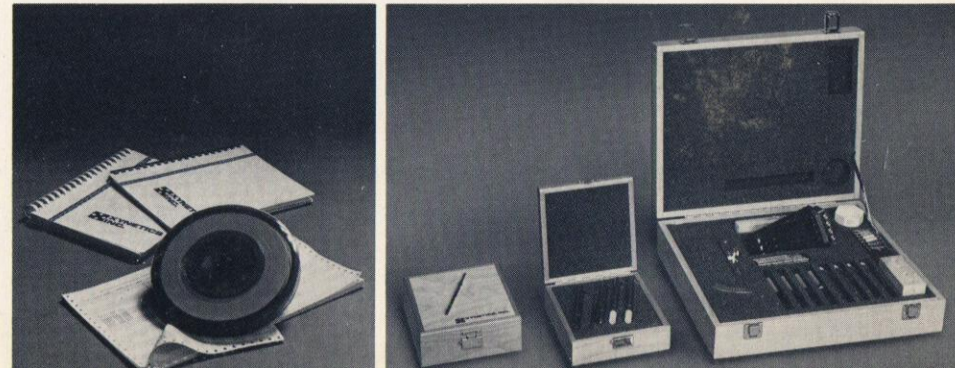

SERIES 1000 PHYSICAL PLANNING INFORMATION

DRAFTING TABLES

Model 1050 48.5" (123cm) high
59" (150cm) wide
49.5" (126cm) deep
Weight: 1200 lbs (544kg)

Model 1100 52" (132cm) high
71" (180cm) wide
67" (170cm) deep
Weight: 2000 lbs (907kg)

Model 1200 53" (135cm) high
103" (262cm) wide
82" (208cm) deep
Weight: 3000 lbs (1360kg)

CONTROLLERS

Model C62 42" (107cm) high
23" (58cm) wide
32" (81cm) deep
Weight: 300 lbs (136kg)

Model C64 Included in Drafting Table

POWER REQUIREMENTS

Standard: 115 vac, 60hz
16 amps

Optional: 115 vac, 50hz
or 230 vac, 50hz single phase

ENVIRONMENT

Temperature: 60°F to 90°F

Humidity: 30% to 60% relative



XYNETICS, INC. For further information or assistance in selecting your plotting system, call or write Xynetics.

WESTERN AREA

Xynetics, Inc.
2901 Coronado Drive
Santa Clara, CA 95051
(408) 246-6500
TWX 910-338-0500

EASTERN AREA

Xynetics, Inc.
550 Pine Town Road
Fort Washington, PA 19034
(215) 628-3393
TWX 510-661-0129

EUROPEAN

Intertrade Scientific, Inc.
205 Talcottville Road
Vernon, CT 06066 U.S.A.
Telephone: (203) 871-0401
Telex: 99392 ITSA VNRN

Intertrade Scientific, Ltd.

Brooklyn House
22 The Green, West Drayton
Middlesex
England
Telephone: West Drayton 45128
Telex: 881/935198 ITSGWD

Intertrade Scientific, GmbH

D-8 Munchen 60
Manzingerweg 7
West Germany
Telephone: 089/883657
Telex: 841/5212560 ITSD

Intertrade Scientific, Sarl

3 bis, Rue Le Corbusier
Silic 239
94528 Rungis Cedex
France
Telephone: 686/7986 or 7988
Telex: 842/260920 EL RUNGI